

M6410C/L, M7410C

Small 3-Position Linear Valve Actuators

PRODUCT DATA

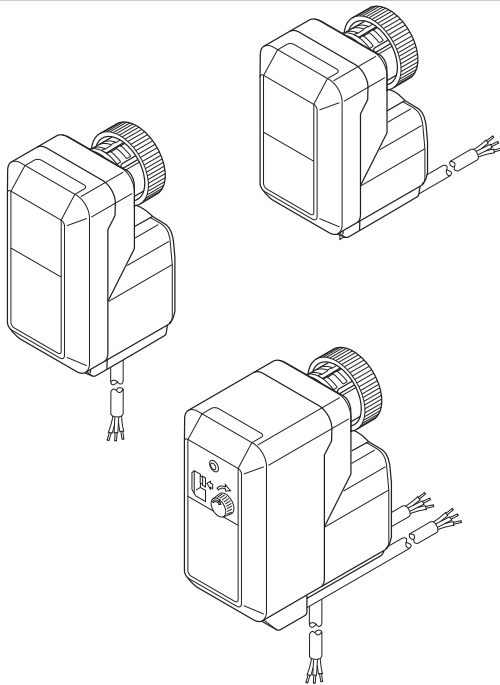

GENERAL

The Honeywell M6410C/L and M7410C actuators are specifically designed to provide floating control together with the V5822/23, V5832/33, V5825B, and VSMF series of small linear valves.

These actuators are used in fan-coil-units, induction units, small reheaters and recoolers, and for zone control applications. They are employed in electronic temperature control systems using hot and/or cold water as the controlled medium.

The M6410C/L and M7410C actuators are suitable for Honeywell Excel series controllers as well as for Honeywell individual room temperature controllers. These controllers track the precise valve position by counting the number of individual control pulses which move the valve from one position to another. For this reason, the actuators do not need end switches or a feedback potentiometer. The absence of these mechanical components ensures long-term reliability.

The actuators are also compatible with any controller providing intelligent position control and having a built-in shut-off function.

These actuators are well suited for applications where space is limited and minimum power consumption is required. The actuators are both attractive and robust in design.

FEATURES

- Small size allows installation where space is limited
- Low power consumption
- Reliable long-term operation because mechanical feedback potentiometers and mechanical end switches are not required
- Magnetic coupling for stem force limitation and self-adjustment of the close-off-point
- Reversible synchronous AC motor
- Suitable for three-position modulating control without proportional feedback
- Supplied with pre-wired connection cable
- Simple, standardized valve/actuator coupling; no tools required for mounting
- Visual valve position indicator furnished with actuators
- Manual operation provided by the valve adjustment cap, extra knob, or with a hexagon key
- Auxiliary switch

SPECIFICATIONS

Motor

Input voltage	24 Vac +10%/-20%; 50/60 Hz 230 Vac +10%/-15%; 50/60 Hz
Power consumption	0.7 VA (24-V models) 7.0 VA (230-V models)*
Control mode	floating
Stroke	6.5 mm
Running time	150 s at 50 Hz, 125 s at 60 Hz
Stem force	version-dependent (see Table 1)
Protection standard	IP 43 as per EN60529
Insulation class	II/III, depending on type (as per EN 60730)
Connection cables	1.5 m
Ambient operating limits	0...60 °C
Medium valve temp.	max. 120 °C
Weight	0.4 kg
Suitable valves	Select in accordance with stem force; see Table 1
Manual operation	see Table 1

*The controller output stage of 230-V models must be suitable for voltage peaks of up to 800 volts.

Auxiliary Switches

Ratings	5...24 V, max. 100 mA 24...230 Vac, max 3 (1) A
Switch position (factory-supplied)	S1 (fixed): 17.8 ± 0.2 mm S2 (adjustable): 11.7 ± 0.2 mm

OPERATION

The actuator is moved by a screw spindle driven in both directions, through a set of gears, by a synchronous motor. A magnetic clutch limits the torque of the gear assembly and the driving force of the actuator.

The actuator is fixed to the valve body by means of a coupling ring requiring no tools for mounting. The actuator is maintenance-free and supplied complete with a ready-to-wire connecting cable.

Table 1. Versions

version	power supply	manual operation	stem force	aux. switch S1	aux. switch S2	housing type	OS number
standard	24 Vac	provided by valve adj. cap	180 N	--	--	A	M7410C1007
	24 Vac		300 N	--	--	B	M7410C1015
with manual operation	24 Vac	integrated	180 N	--	--	C	M6410C2023
	24 Vac		300 N	--	--	C	M6410C2031
	230 Vac		180 N	--	--	C	M6410L2023
	230 Vac		300 N	--	--	C	M6410L2031
with manual operation and aux. switches	24 Vac	integrated	180 N	X	X	C	M6410C4029
	24 Vac		300 N	X	X	C	M6410C4037
	230 Vac		180 N	X	X	C	M6410L4029
	230 Vac		300 N	X	X	C	M6410L4037

MOUNTING

The actuator may be mounted only beside or above the valve. Adjust the valve to the correct position before mounting.

The actuator must be mounted by hand. Do not use tools or additional force as this may damaged actuator and valve.

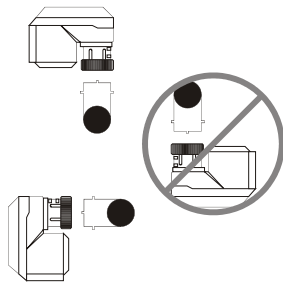

Fig. 1. Mounting positions

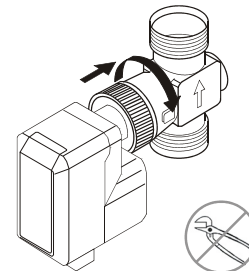

Fig. 3. Mounting the actuator

Before the actuator is fixed to the valve, remove the adjustment cap (Fig. 2). Ensure that the actuator is in the retract (factory-supplied) position before fixing the actuator to the valve body.

ELECTRIC WIRING OF MOTOR

A fuse with a contact gap of at least 3 mm for each pole must be fitted with the fixed installation. The fuse rate is max. 2 A. The electrical installation must comply with Fig. 4.

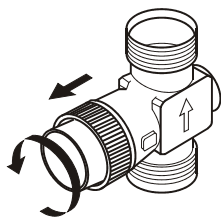

Fig. 2. Remove protection cap

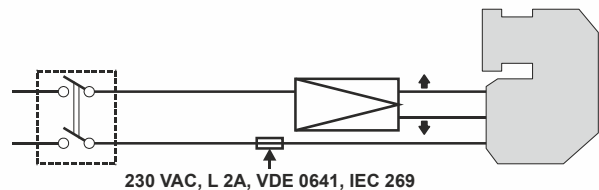

Fig. 4. Electric wiring of motor



CABLE COLORS FOR 24-V MODELS (M6410C, M7410C)		
COM		
WHITE	GREEN	BROWN
CABLE COLORS FOR 230-V MODELS (M6410L)		
WORKING PORT A		
V58x2A (DN15, DN20)	OPEN 	CLOSE 
V5832B (DN25-DN40), VSMF, V5825B	CLOSE 	OPEN 
DN15-DN40	CLOSE 	OPEN 
DN15, DN20	CLOSE 	OPEN 

Fig. 5. Cable colors, valve action

MANUAL OPERATION

The actuators with integrated manual operation (see Table 1) feature a hexagonal key hole for manual operation. For more comfort, an additional knob for manual adjustment is packed separately. To avoid damaging the valve, separate the actuator from the power supply before adjusting manually.

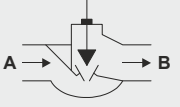
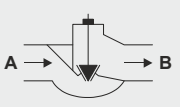
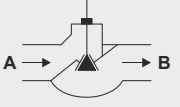
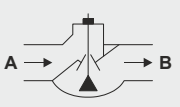
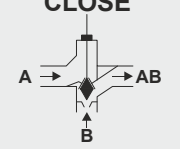
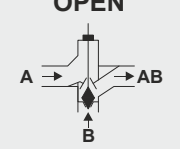
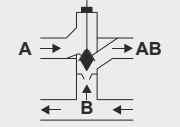
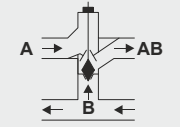
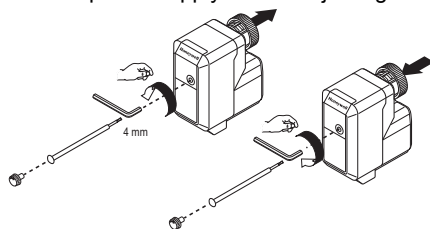

Fig. 6. Manual operation

COMMISSIONING

A functional check of the valve actuator can be carried out by changing the controller setpoint by 5 °C or more. The resultant movement of the actuator stem (Fig. 7) indicates whether the valve is opening or closing.

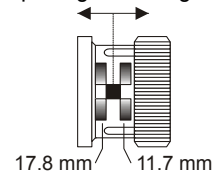

Fig. 7. Movement of the actuator stem

AUXILIARY SWITCHES

The actuators with the OS-number M****40** feature two auxiliary switches, each with its own cable. Auxiliary switch S1 switches when the stem reaches its fixed switchpoint. Auxiliary switch S2 switches when the stem reaches its adjustable switchpoint.

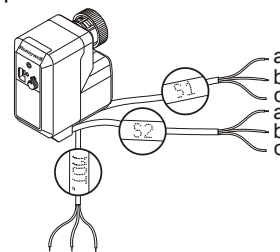

Fig. 8. Auxiliary switch cables

Adjustment of Auxiliary Switch 2

Auxiliary switch 2 should be adjusted by skilled personnel, only.

Move the actuator to the position where the switch is to be tripped. Cut the plastic skin with a sharp knife. The adjustment screw is accessible below the skin. First turn the screw clockwise until the end stop is reached. Then turn the screw counterclockwise until the switch point is achieved. To check that the required position has been set, move the actuator. Finally, seal the adjustment hole with a piece of tape.

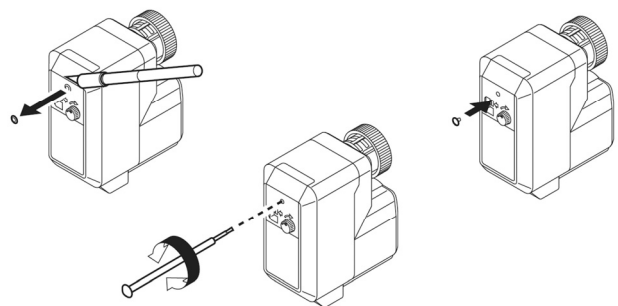

Fig. 9. Adjustment of auxiliary switch S2

Electric Wiring of Auxiliary Switches

The electrical installation must comply with Fig. 10. If the auxiliary switch is connected to 230 Vac, a switch with a contact gap of at least 3 mm for each pole must be fitted with the installation.

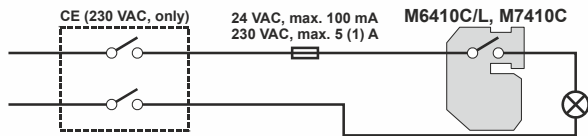

Fig. 10. Electric wiring of auxiliary switch

V58x2A (DN15, DN20)	OPEN 		CLOSE
V5832B (DN25-DN40), VSMF, V5825B	CLOSE 		OPEN
DN15-DN40	CLOSE 		OPEN
DN15, DN20	CLOSE 		OPEN
S1	BROWN BLUE BLACK	BROWN BLUE BLACK	BROWN BLUE BLACK
S2	BROWN BLUE BLACK	BROWN BLUE BLACK	BROWN BLUE BLACK

Fig. 11. Cable colors, valve action

Application Example: Switching Off an Electrical Appliance 2-Way-Valve (N.O.), S2

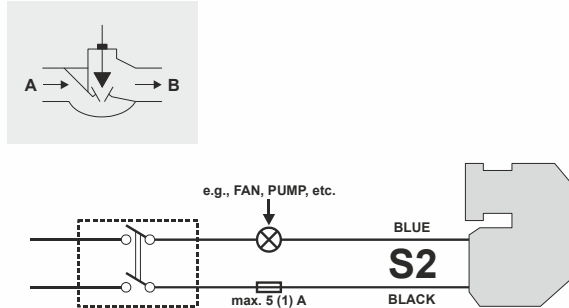

Fig. 12. Application example of auxiliary switch

All Other Valves (N.C.), S1

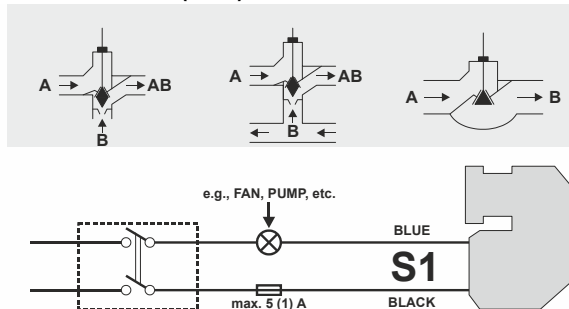

Fig. 13. Application example of auxiliary switch

DIMENSIONS (mm)

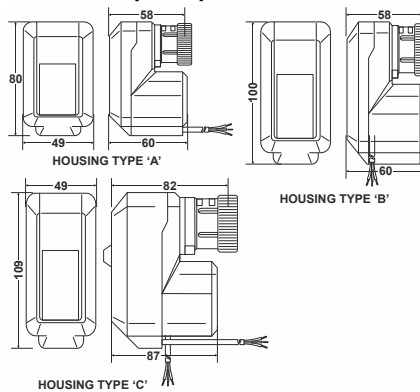

Fig. 14. Housing types

Honeywell

Manufactured for and on behalf of the Environmental and Combustion Controls Division of Honeywell Technologies Sàrl, Rolle, Z.A. La Pièce 16, Switzerland by its Authorized Representative:

Automation and Control Solutions

Honeywell GmbH
 Böblinger Strasse 17
 71101 Schönaich, Germany
 Phone +49 (0) 7031 637 01
 Fax +49 (0) 7031 637 740
<http://ecc.emea.honeywell.com>

EN0B-0096GE51 R0914

Subject to change without notice